

C. Street, G. Frazee,  
C. Fredrickson,  
I. Harvey, T.H. Killilea



October  
2014

# Rheology as a Tool for Sealant Formulation – Part I

Acknowledgements: K. Kirkwood, R. Simon, K. Porter

# *Speaker Introduction*

- Carrie Street – Materials Engineer II, Engineered Polymer Solutions
  - BS in Chemical Engineering (University of Oklahoma 2007)
  - PhD in Chemical Engineering (University of Delaware 2012)
  - Engineered Polymer Solutions (2012 – Present)
    - Lead physical sciences research team
    - Fundamental understanding of physical and thermal behavior of polymers and formulated systems

# *Agenda*

- Sealant Formulation Strategy
- Rheology
  - Background and Key Terms
- Quantitative Measurements
  - Target Parameters
- Conclusions

# Water Based Latex Sealants: Start to Finish

Formulation

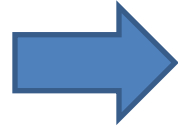

Application

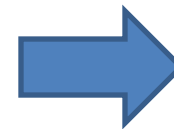

Final  
Properties

Iterative  
process  
based on  
experience/  
trial and  
error

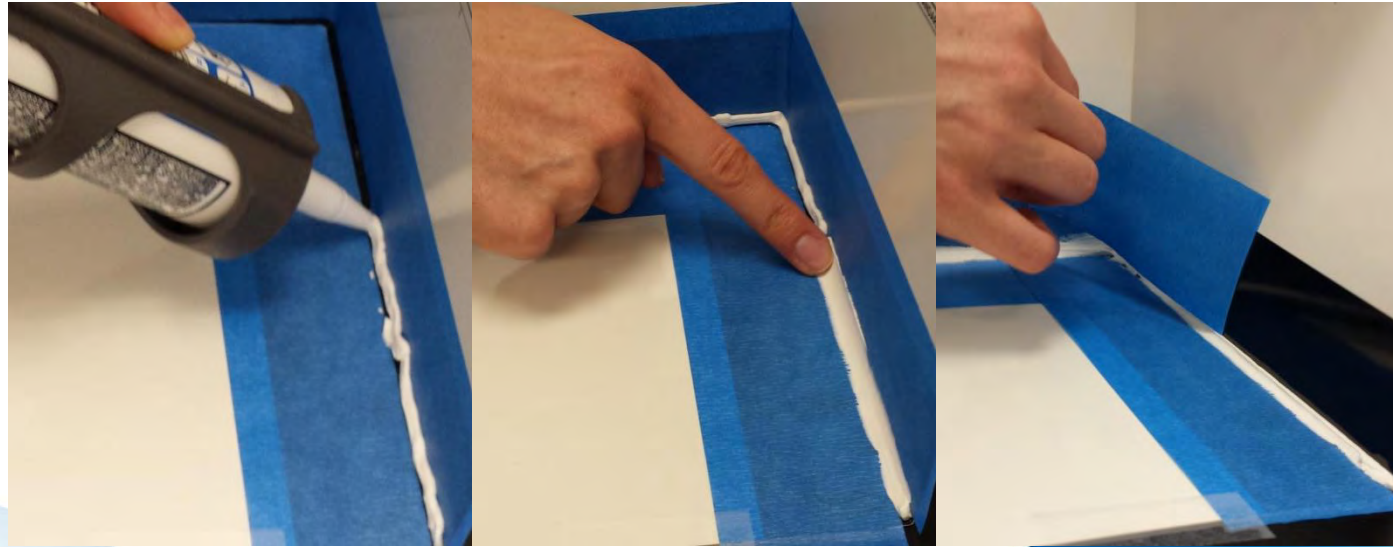



# Standard Tests for Wet Sealants

- Dispensing (ASTM C1183)
- Slump (ASTM D2202)
- Tooling – Sliding
- Tooling – Tapping



# Sealants: Start to Finish

Formulation

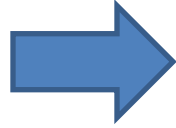

Application

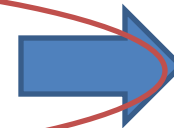

Final  
Properties

## Rheology

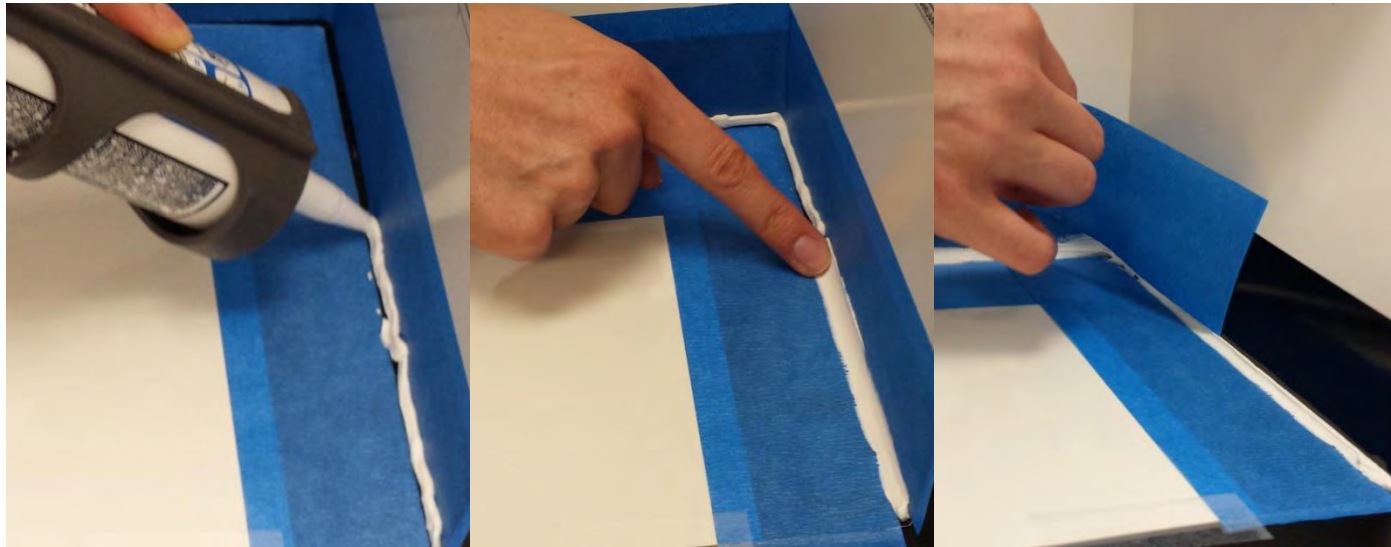

- Quantify physical properties
- Use target parameters to **Accelerate Product Development**

# Rheology for Physical Properties

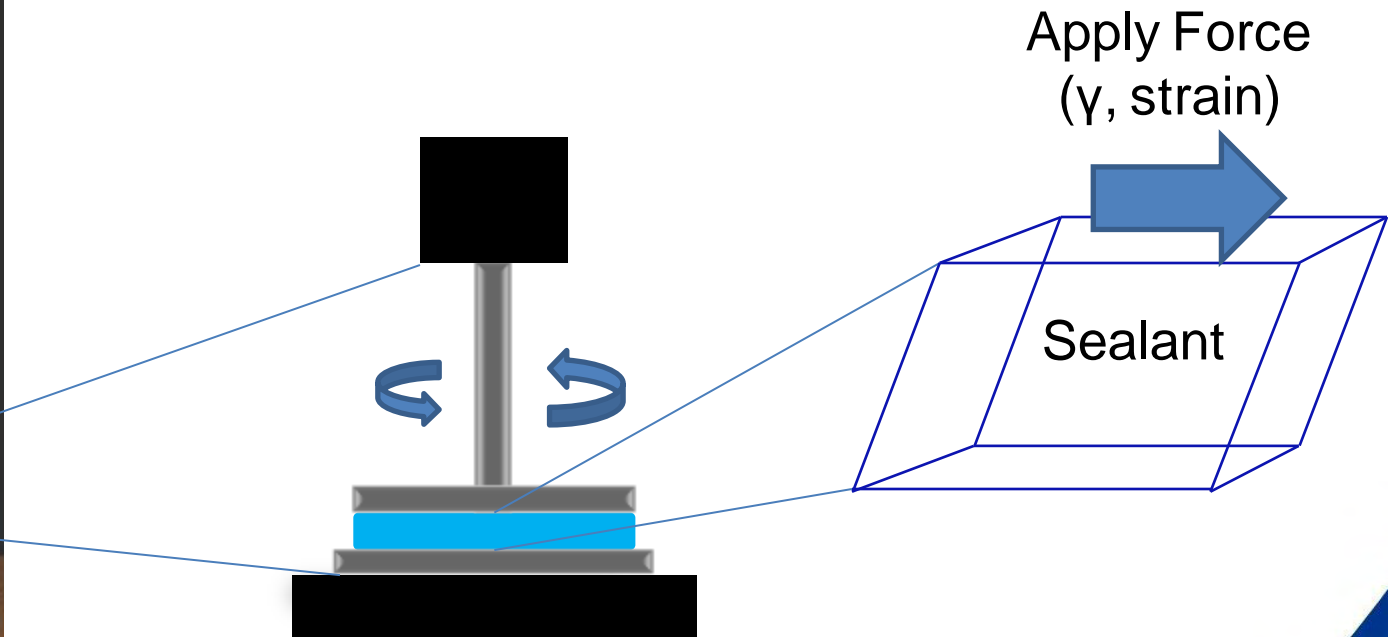

Examples:  $G'$  = elastic character  
rubber

$G''$  = liquid character  
sealants water

# Rheology Procedure to Simulate Tooling

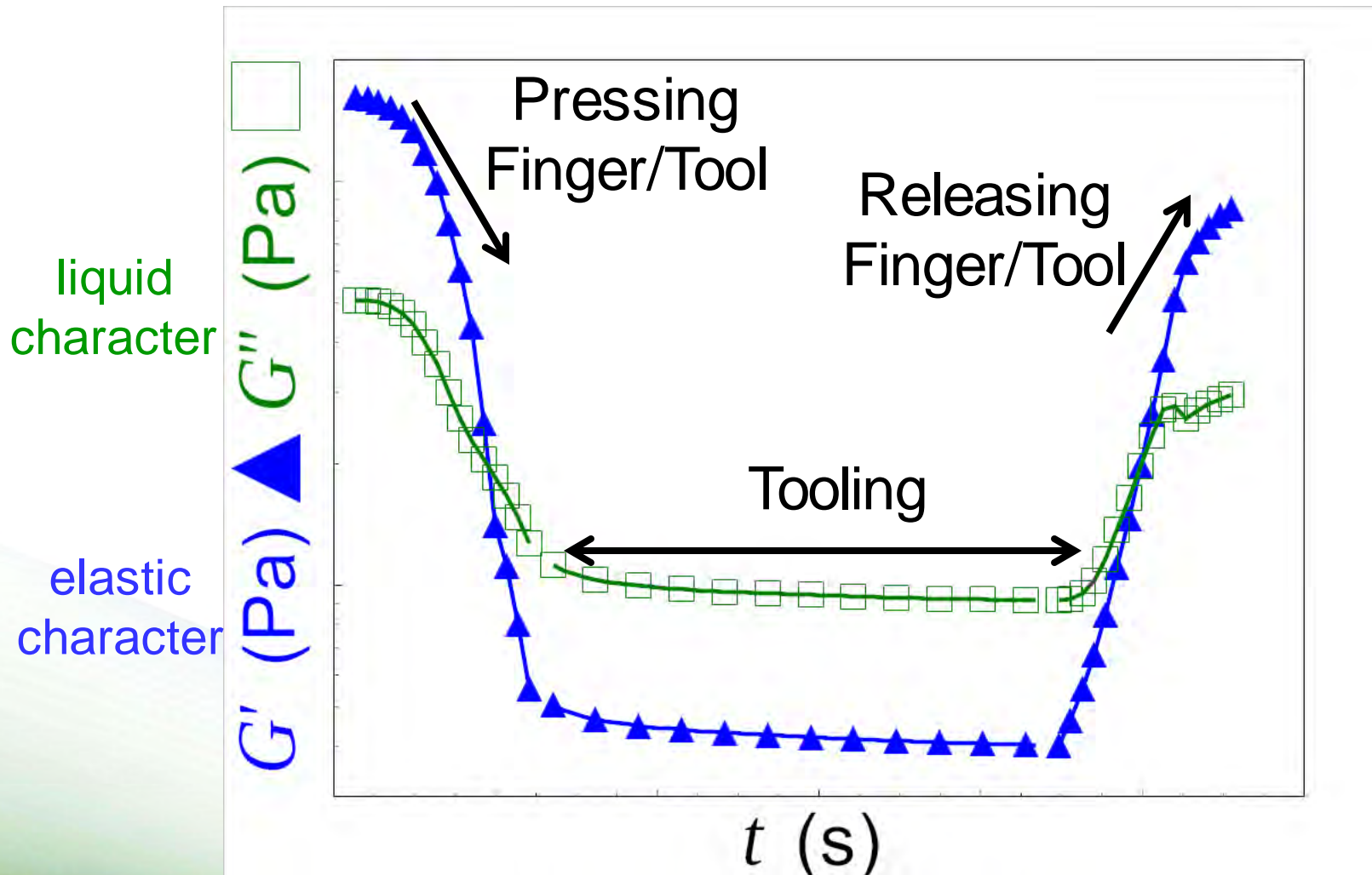



# Relating Rheology to Standard Tests: Pressing Finger/Tool

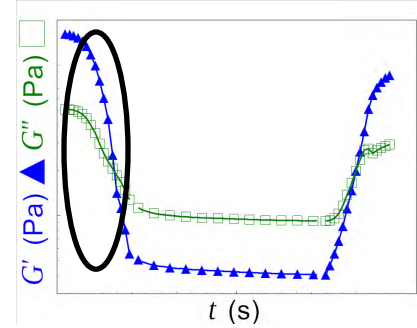

liquid character

elastic character

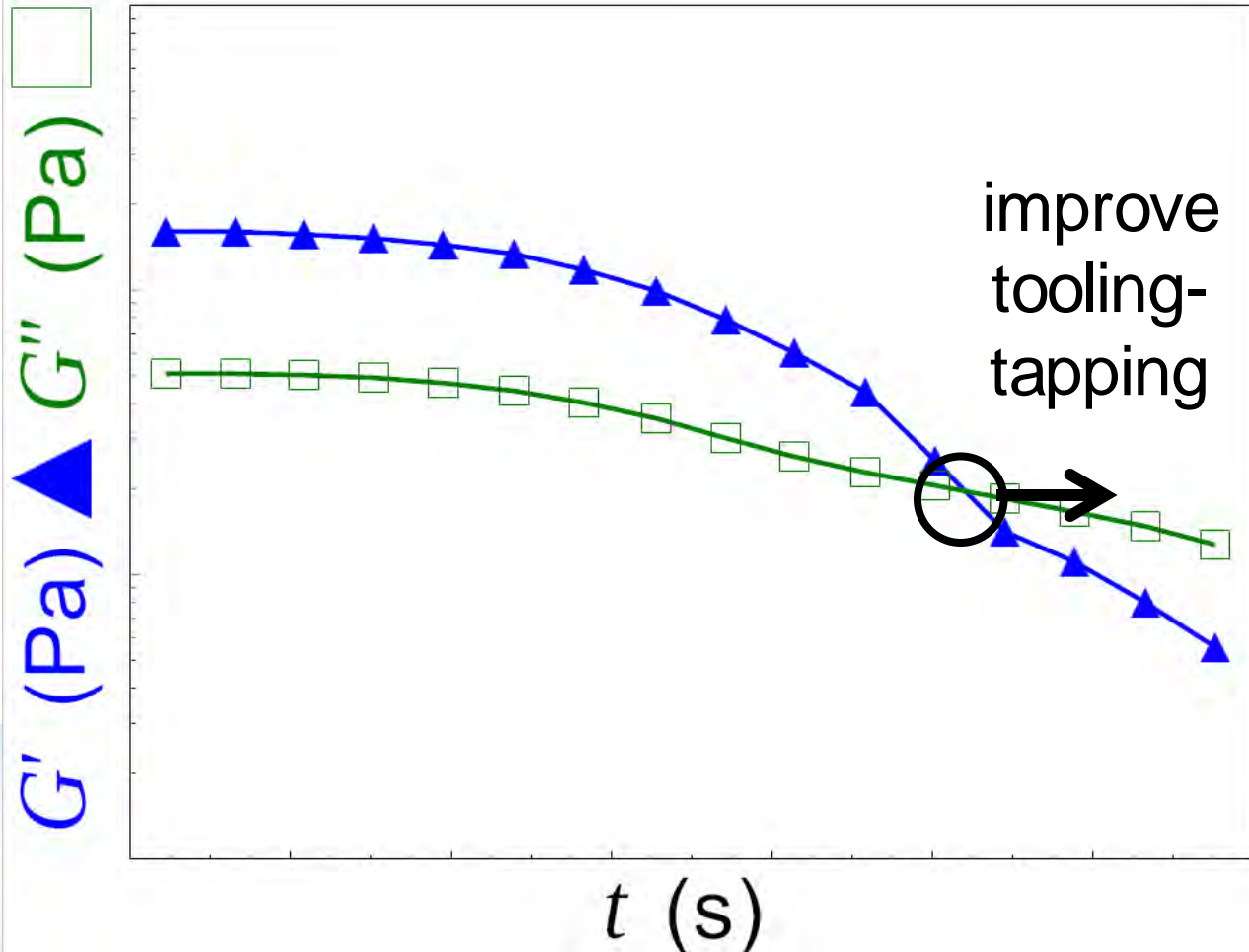

(increasing Force  $\rightarrow$ )

# Relating Rheology to Standard Tests: Tooling

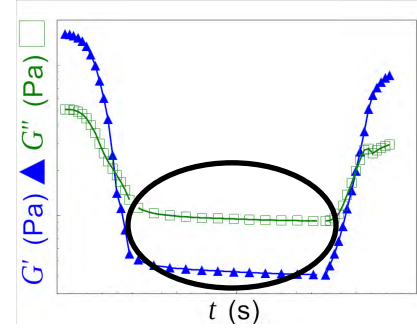

liquid character

elastic character

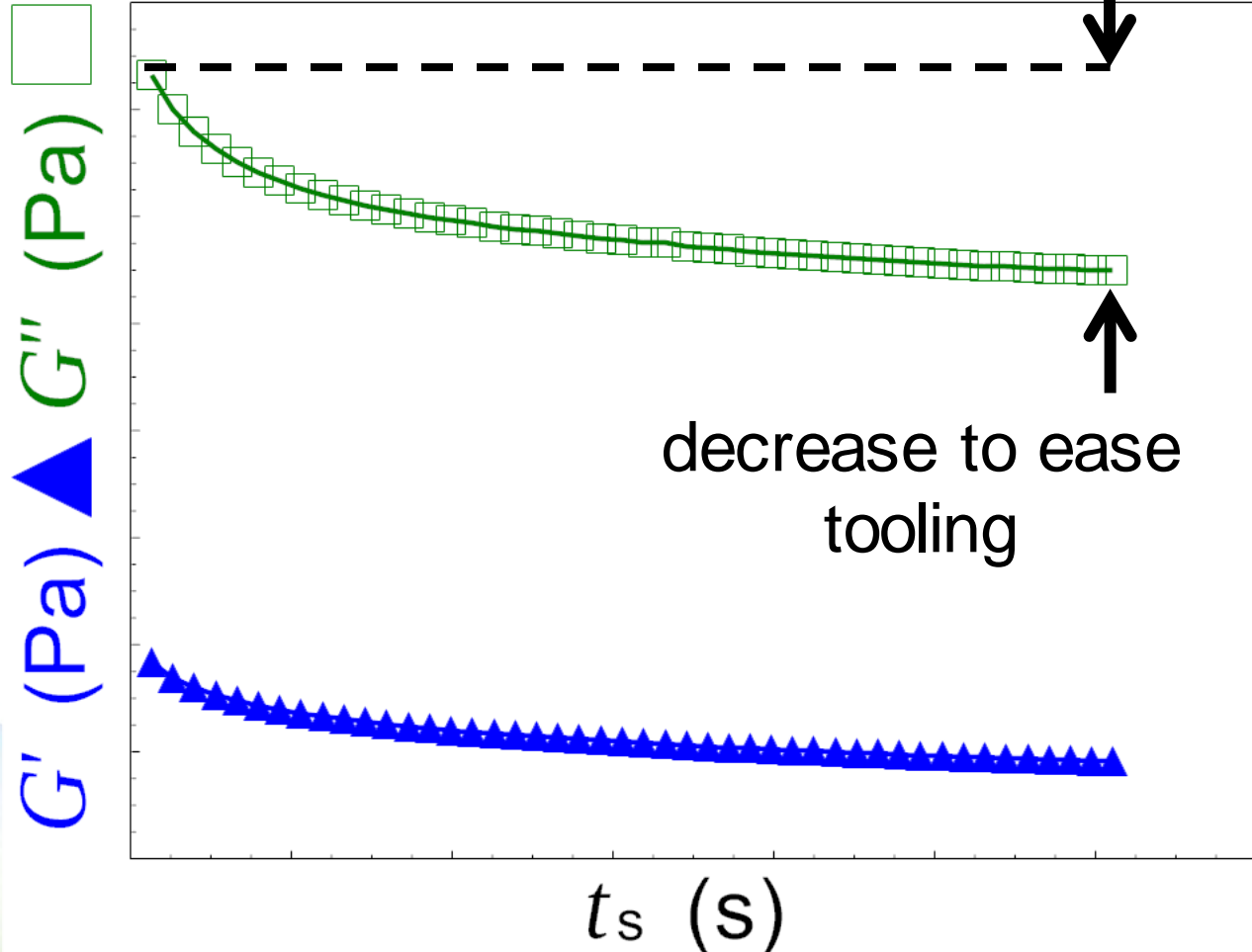

# Relating Rheology to Standard Tests: Removing Finger/Tool

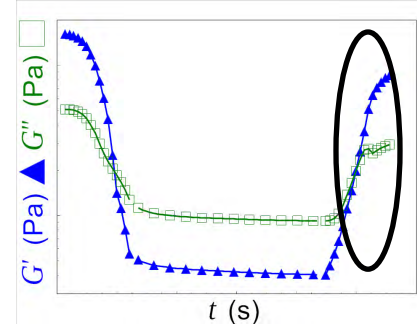

liquid  
character

elastic  
character

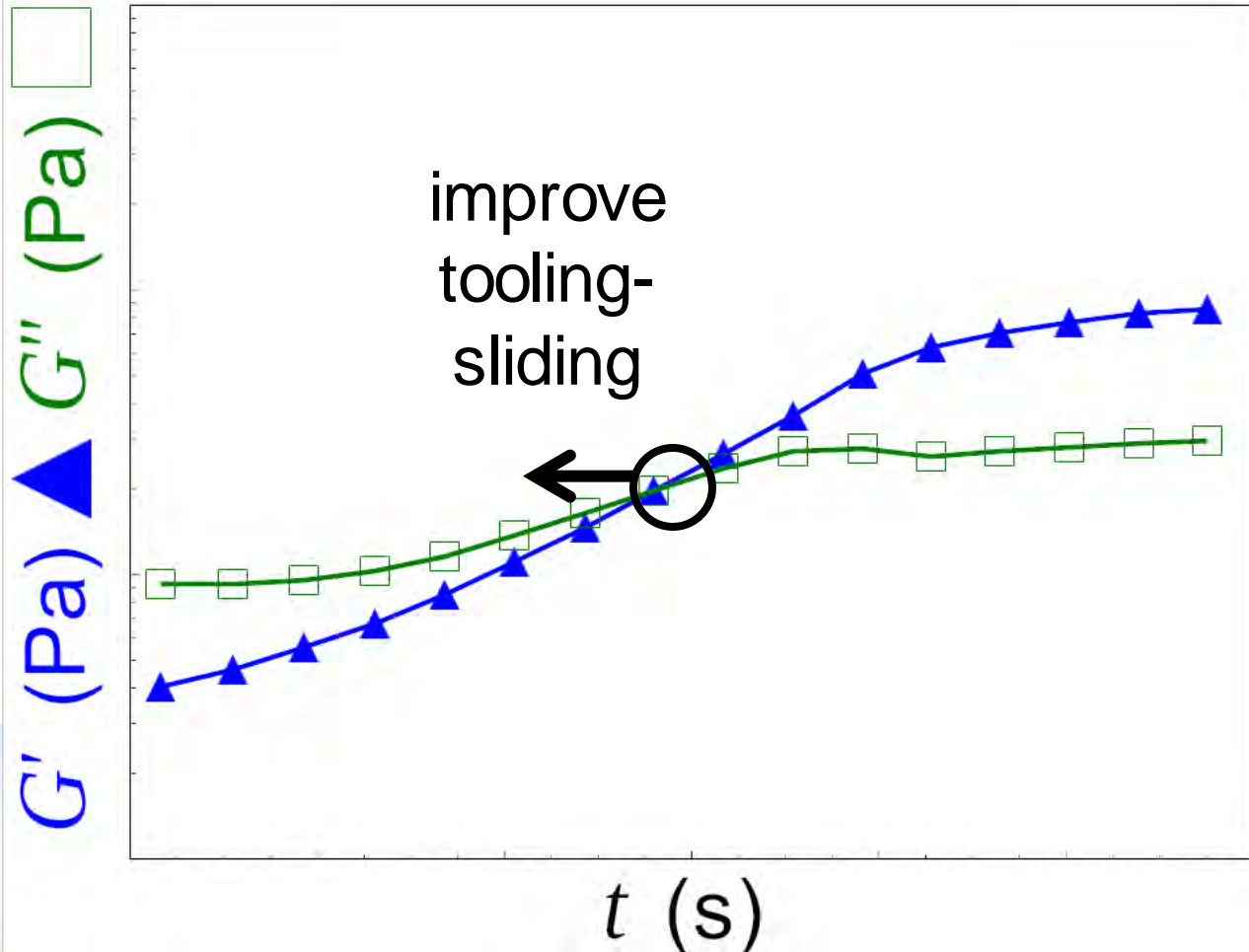

(decreasing Force  $\rightarrow$ )

# Design of Experiments Formulation Variables

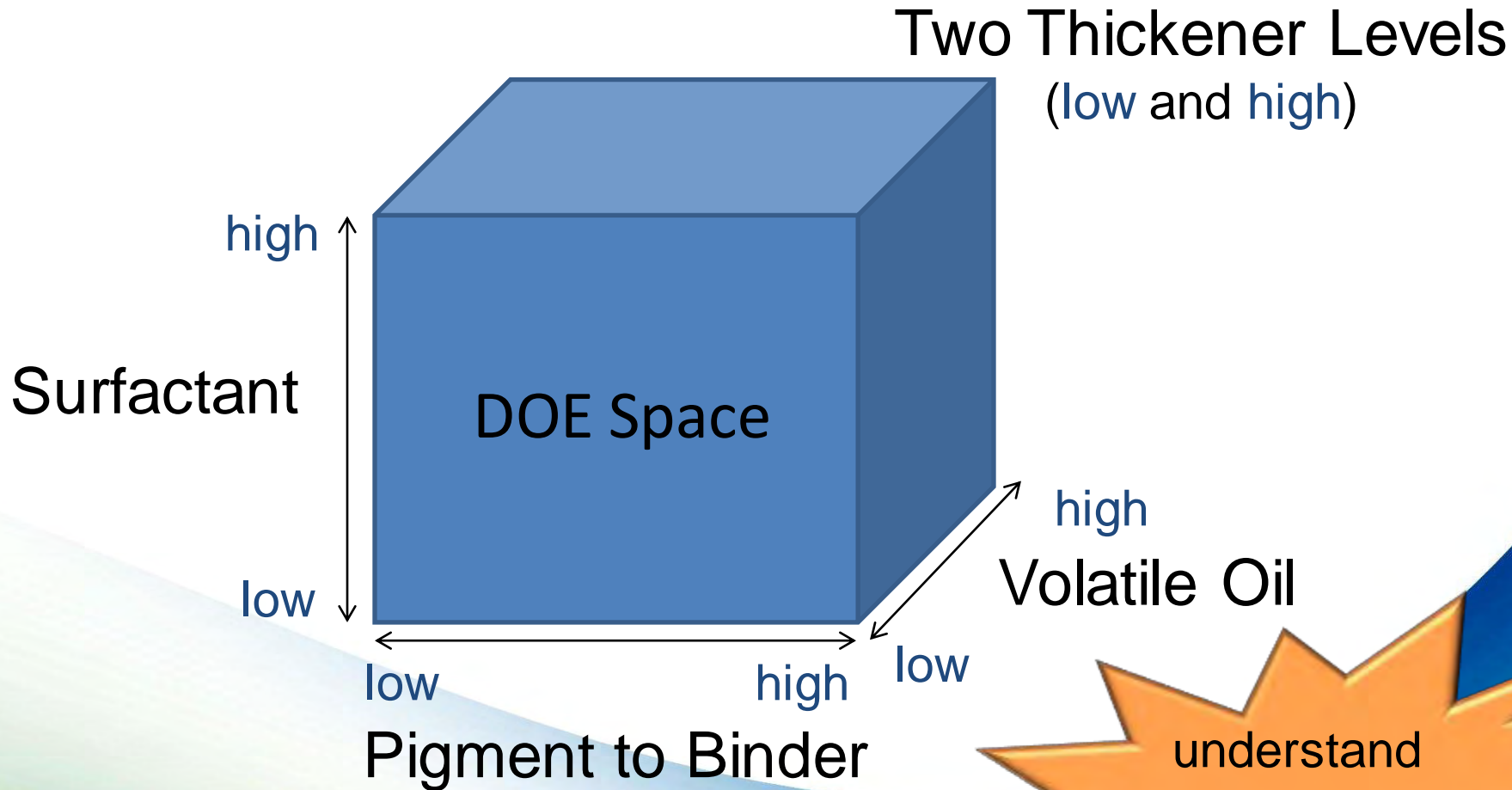

understand  
multiple  
factors



# Target Parameters for Product Development

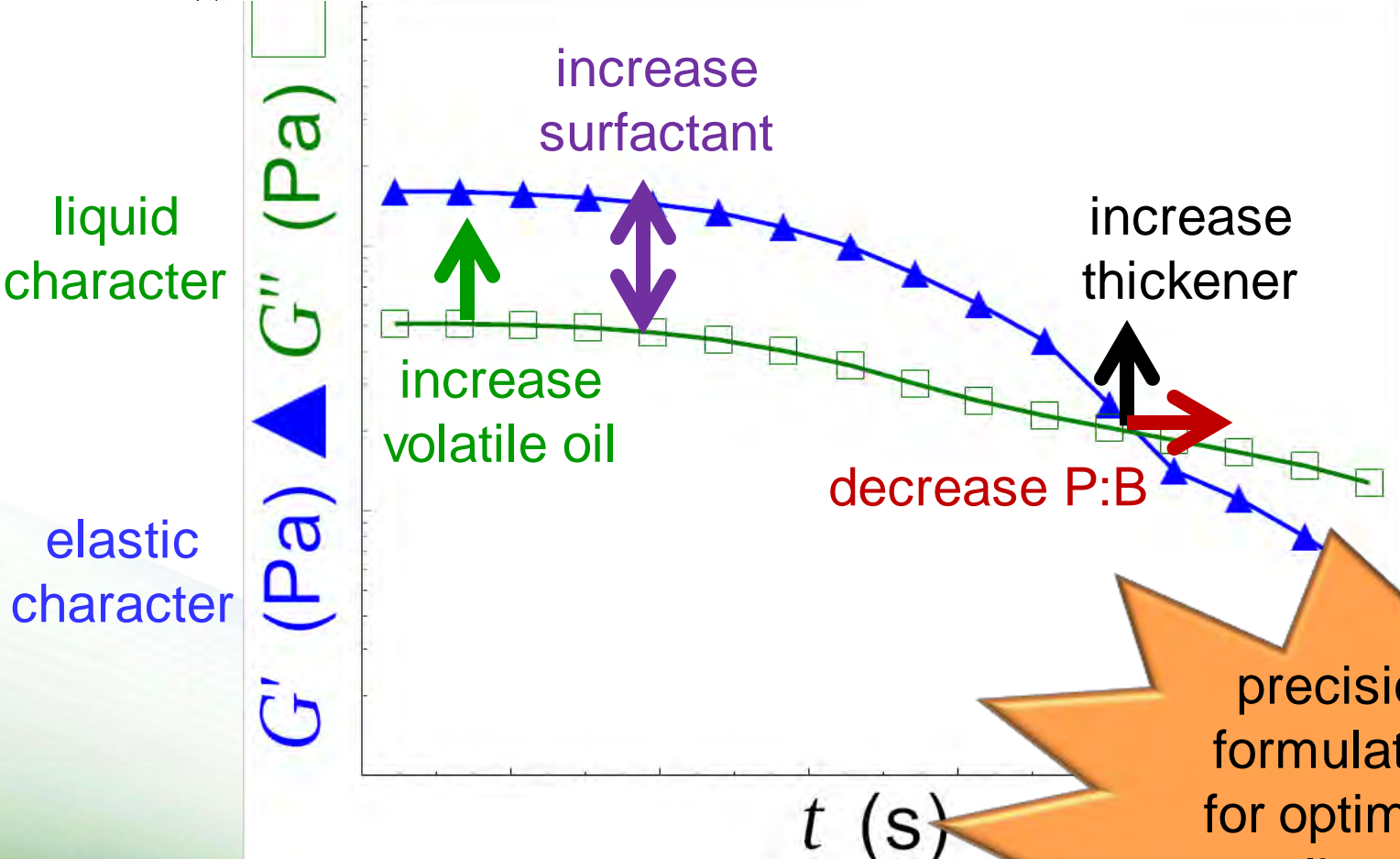
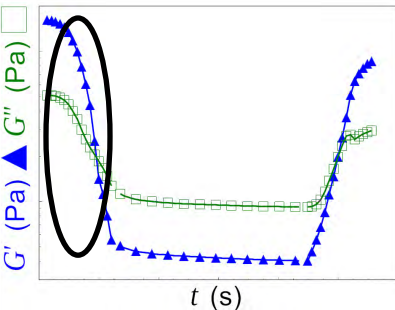

precision formulation for optimum application

# Advantage of Rheology: Tooling-Tapping

## Standard Rating

## Rheological Measure

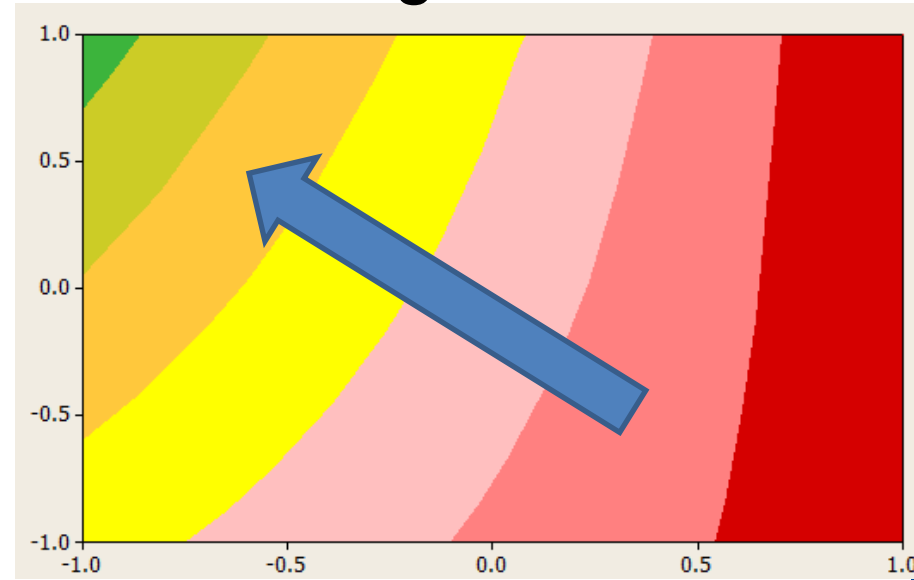
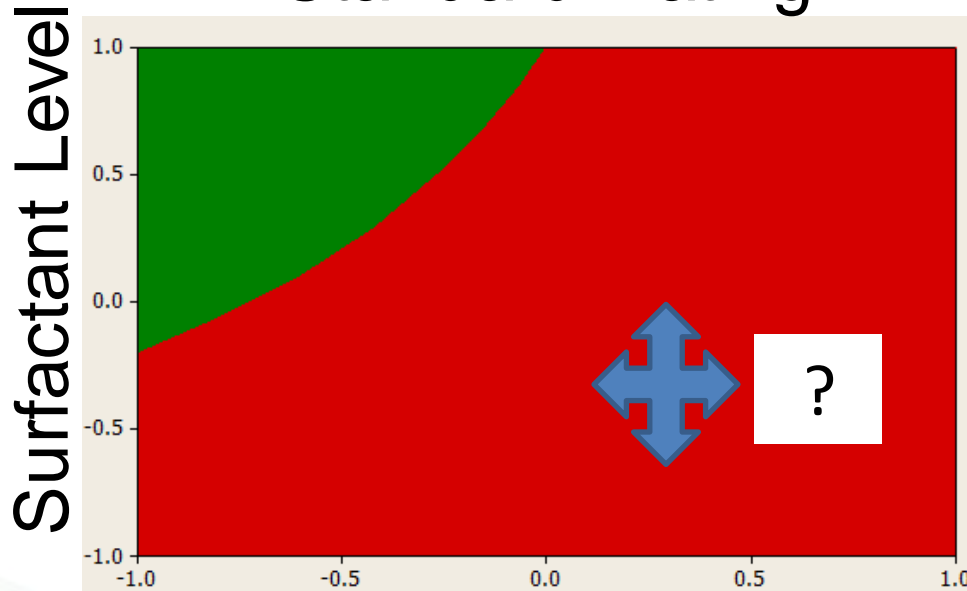

Pigment to Binder Level

Pigment to Binder Level

➤ ***Rheology provides resolution and directionality***

# Advantage of Rheology: Tooling-Sliding

Standard Rating

Rheological Measure

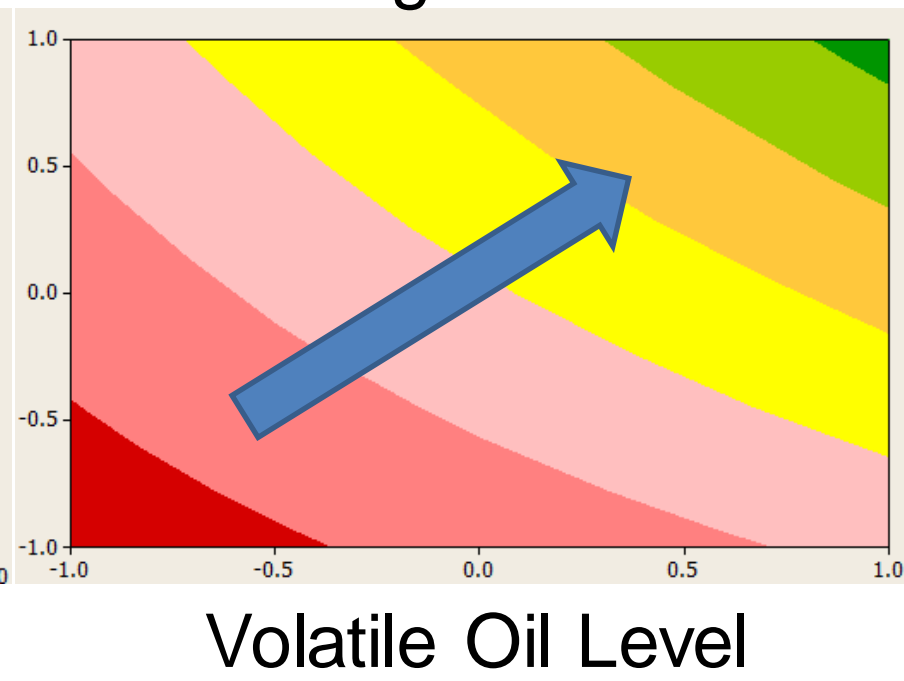
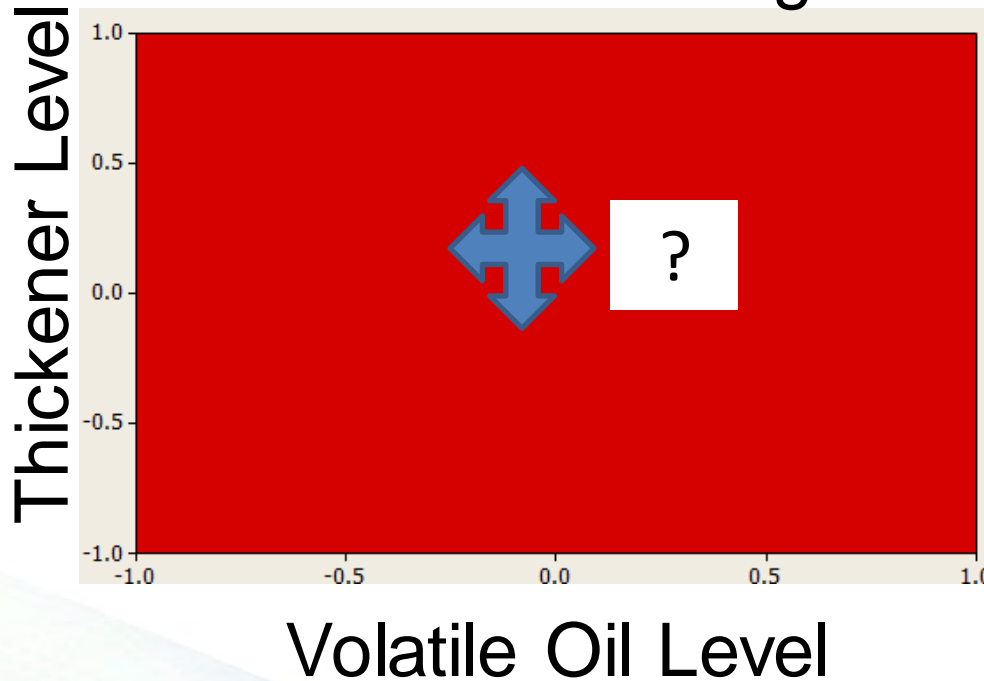

➤ ***Rheology provides resolution and directionality***

# Conclusions: Rheology for Sealant Formulation – Part I

- Quantitative physical properties as target parameters for product development
- Accelerated product development

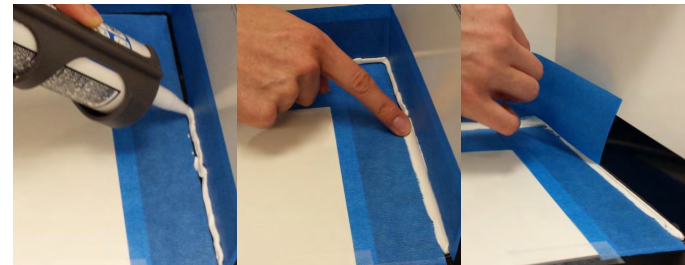
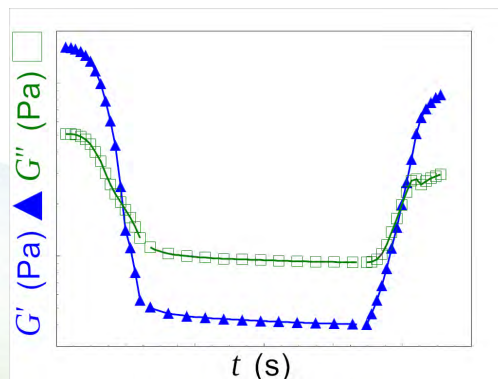



## Future Work

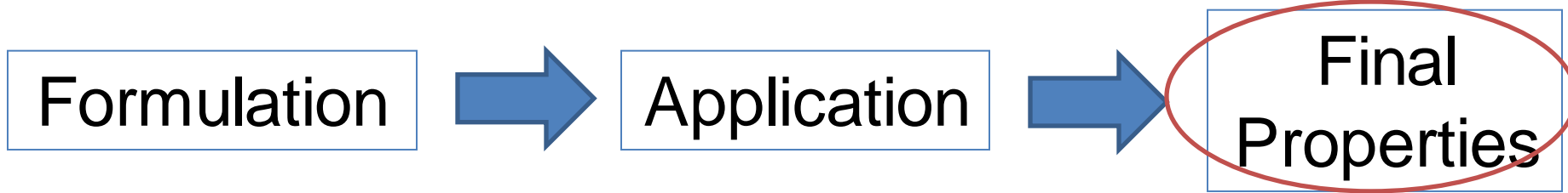

## Rheology

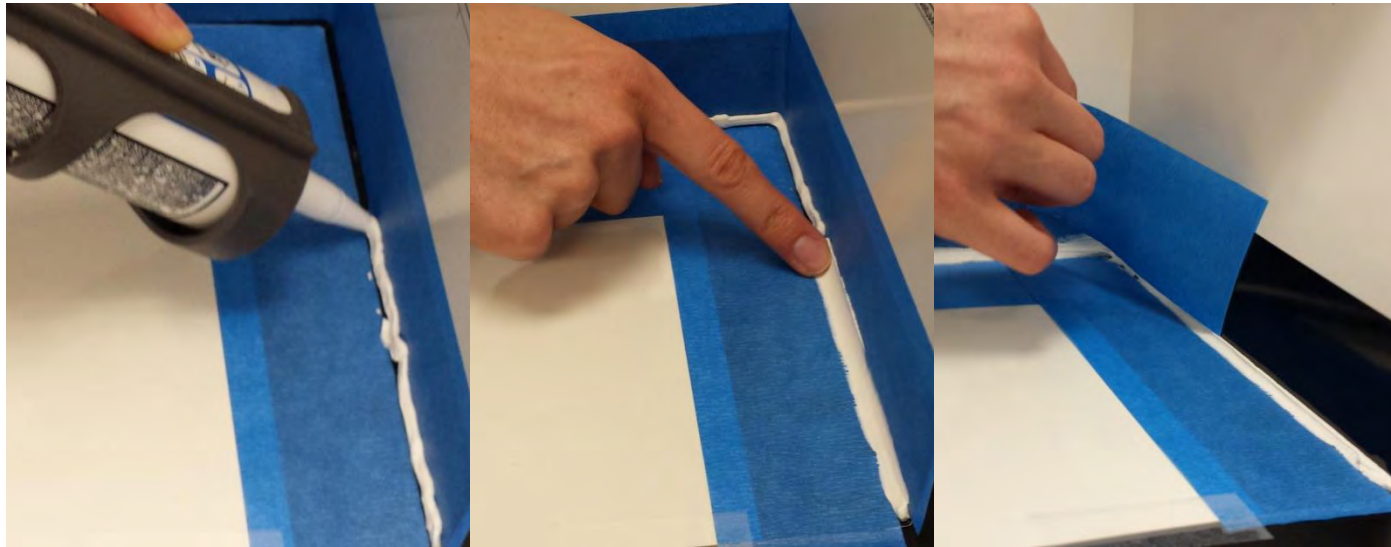

- Quantify final performance properties
- Use target parameters to ***Accelerate Product Development***